

VASCA IN ACRILICO 120X70

ACRYLIC BATHTUB 120X70

DATI TECNICI

TECHNICAL INFO

Vista in pianta
plan view

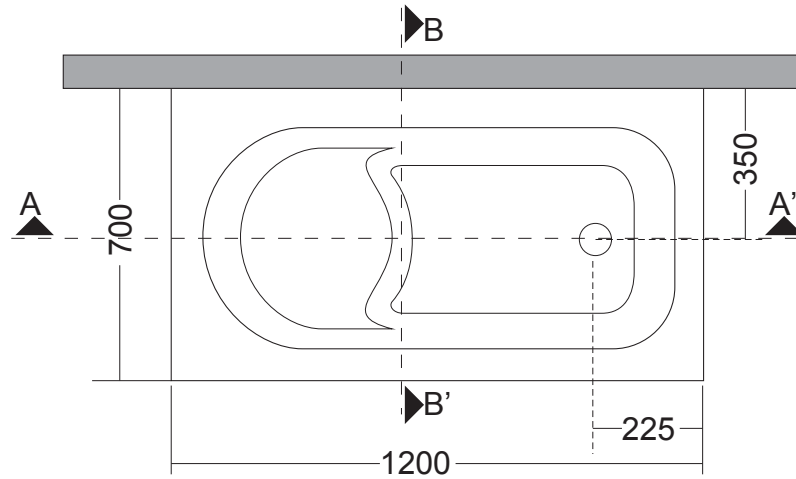

Sezione A/A'
Section A/A'

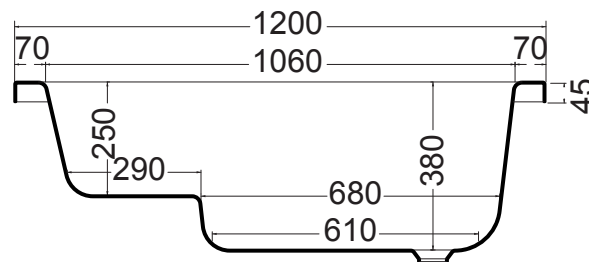

Sezione B/B'
Section B/B'

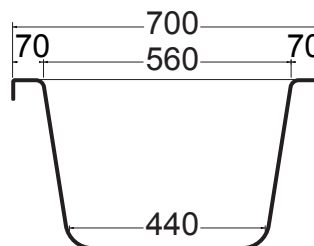

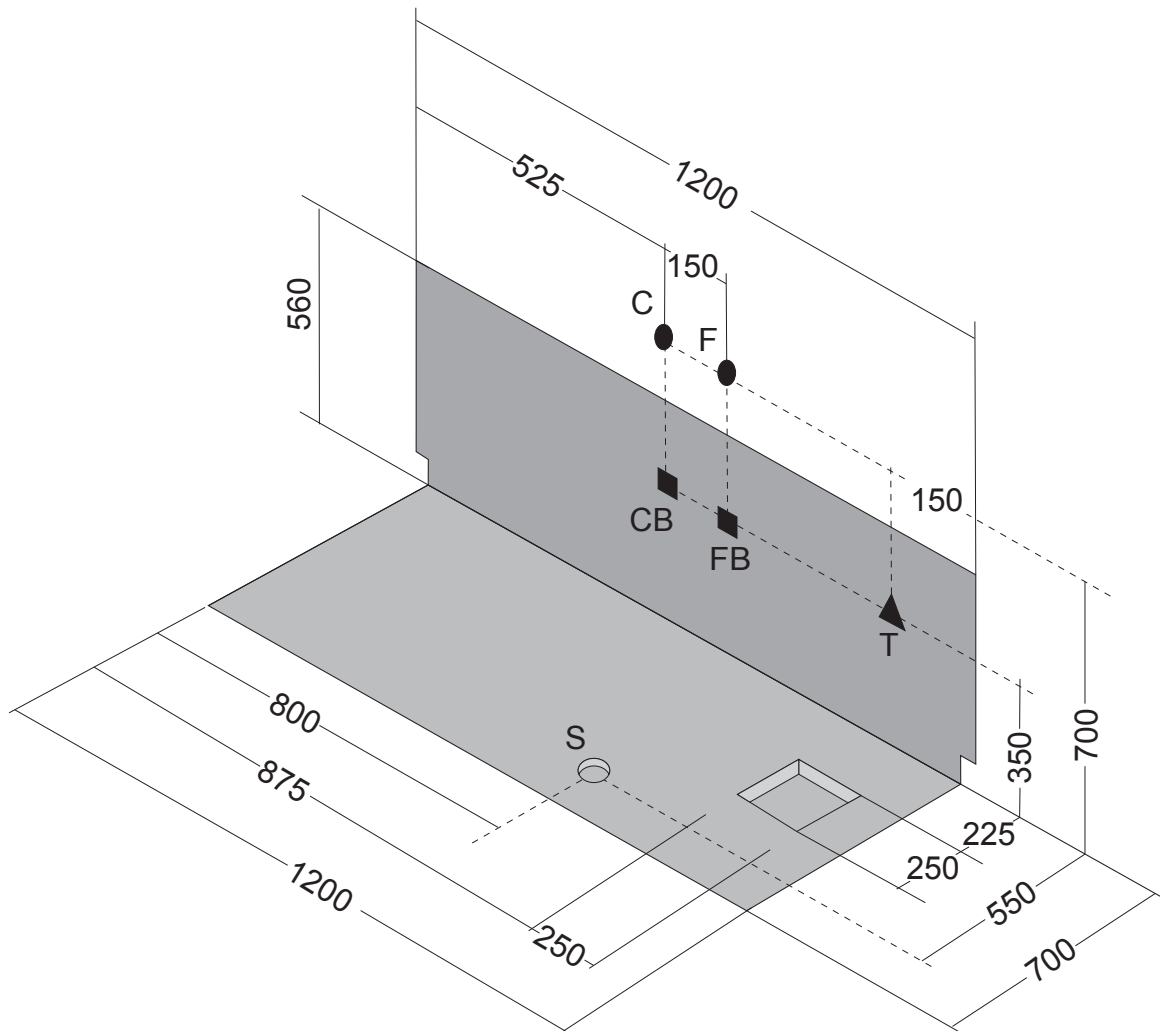

Ingombro vasca proiettato nel muro









Bath overall dimensions as projected on the wall

VASCA IN ACRILICO 120X70

DATI TECNICI

ACRYLIC BATHTUB 120X70

TECHNICAL INFO

I	CARATTERISTICHE IDRAULICHE	REQUISITI DI PREINSTALLAZIONE	COMBINAZIONI RUBINETTERIA
<p>N.B. L'INSTALLAZIONE DEVE AVVENIRE A PAVIMENTO E PARETI FINITE</p>	<p>Numero jets: 0</p>	<p>C : Allaccio acqua calda rubinetteria parete: 1/2" F : Allaccio acqua fredda rubinetteria parete: 1/2" CB : Allaccio acqua calda bordo vasca: 1/2" FB : Allaccio acqua fredda bordo vasca: 1/2" T : Allaccio miscelatore per erogazione da troppopieno: 1/2" S : Allaccio scarico incassato a pavimento: 1-1/2"</p>	<p>C F : Rubinetteria parete </p>
<p>Peso netto: Kg 20 Peso spedizione: Kg 25 Volume spedizione: m3 = 0,777 Contenuto acqua: Lt 100</p>			<p>CFT: Rubinetteria parete con erogazione troppopieno </p> <p>CB BF: Rubinetteria bordo vasca </p>
GB	WATER SYSTEM SPECIFICATION	CONDITION REQUIRED BEFORE THE INSTALLATION	TAPS COMBINATION
<p>N.B. THE INSTALLATION MUST BE CARRIED OUT WITH FLOOR AND WALLS ALRESDY TILED</p>	<p>Numero jets: 0</p>	<p>C : Wall taps outlet for hot water: 1/2" F : Wall taps outlet for cold water: 1/2" CB : Bath edge taps outlet for hot water: 1/2" FB : Bath edge taps outlet for cold water: 1/2" T : Single outlet for mixed water to supply by overflowing: 1/2" S : Drainage outlet istalled in the floor: 1-1/2"</p>	<p>C F : Wall taps </p>
<p>Net weight: Kg 20 total weight with package: Kg 25 Volume with package: m3 = 0,777 Water capacity: Lt 100</p>			<p>CFT: Wall taps with water supply by overflowing </p> <p>CB BF: Bath edge taps </p>
F	WATER SYSTEM SPECIFICATION	CONDITION REQUIRED BEFORE THE INSTALLATION	TAPS COMBINATION
<p>N.B. THE INSTALLATION MUST BE CARRIED OUT WITH FLOOR AND WALLS ALRESDY TILED</p>	<p>Numero jets: 0</p>	<p>C : Wall taps outlet for hot water: 1/2" F : Wall taps outlet for cold water: 1/2" CB : Bath edge taps outlet for hot water: 1/2" FB : Bath edge taps outlet for cold water: 1/2" T : Single outlet for mixed water to supply by overflowing: 1/2" S : Drainage outlet istalled in the floor: 1-1/2"</p>	<p>C F : Wall taps </p>
<p>Net weight: Kg 20 total weight with package: Kg 25 Volume with package: m3 = 0,777 Water capacity: Lt 100</p>			<p>CFT: Wall taps with water supply by overflowing </p> <p>CB BF: Bath edge taps </p>